

Lot 351 Beachgrove

Stage 6B, Beachgrove, Kaiapoi, North Canterbury



Artist impression only – refer to concept plan.





House & Land Package:

\$739,900

Family sized home featuring three bedrooms, master with ensuite, open plan kitchen living and dining, family bathroom and internal access garaging. Well appointed for the sun on a fully landscaped section, offering quality fixtures and fittings throughout.

Home area: 143m²

Section area: 325m²

 3  1  2  2

Features:

- Turnkey
- Master Build 10-Year Guarantee
- 1 year warranty period
- Healthy Homes compliant
- RibRaft foundation
- Modern bathroomware
- Custom kitchen cabinetry
- Tri-Stone benchtop
- Window coverings
- Fully landscaped

P: (03) 977 2832

E: info@oakridgehomes.co.nz

oakridgehomes.co.nz

Floor Layout

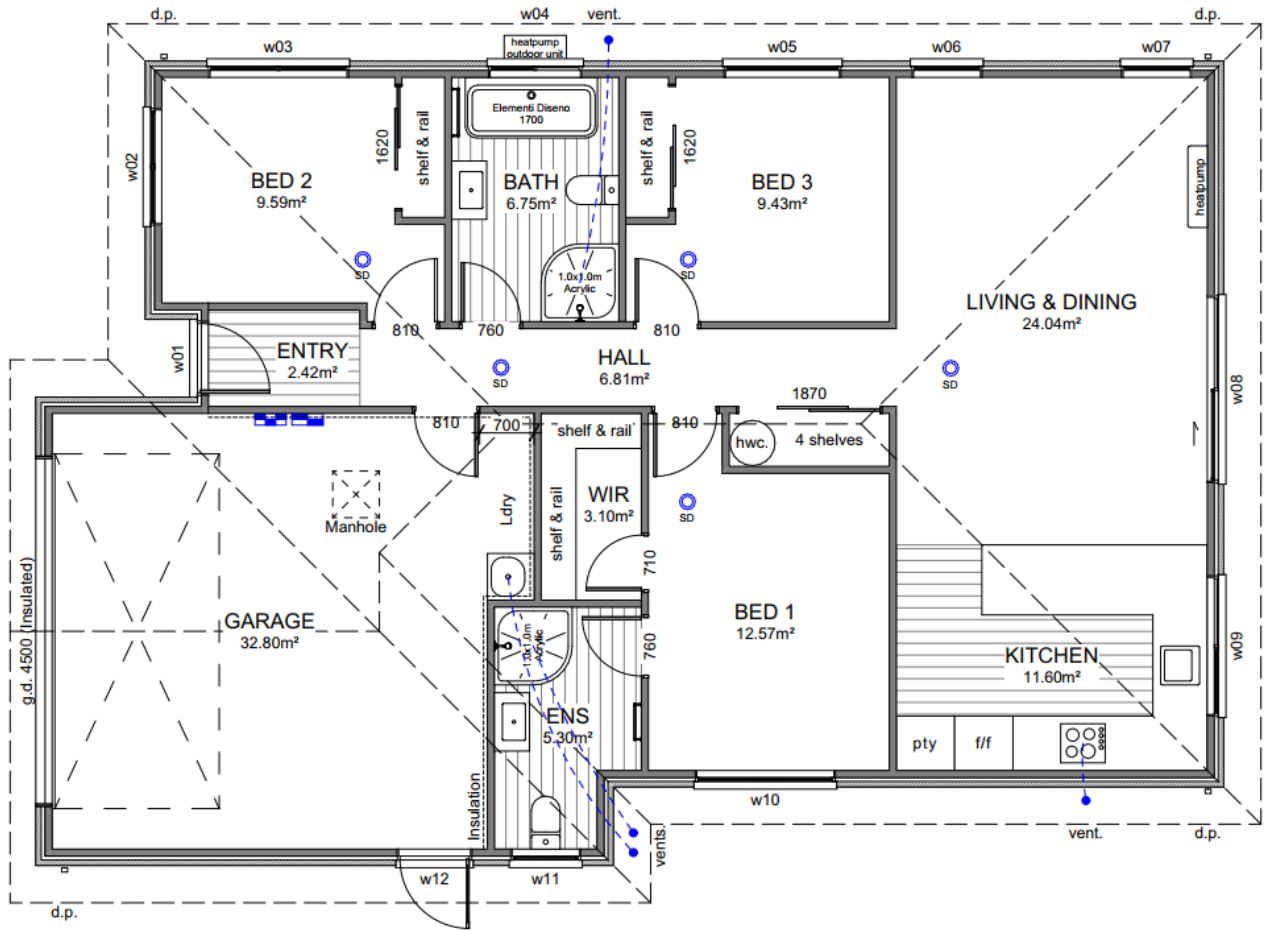

Site Location

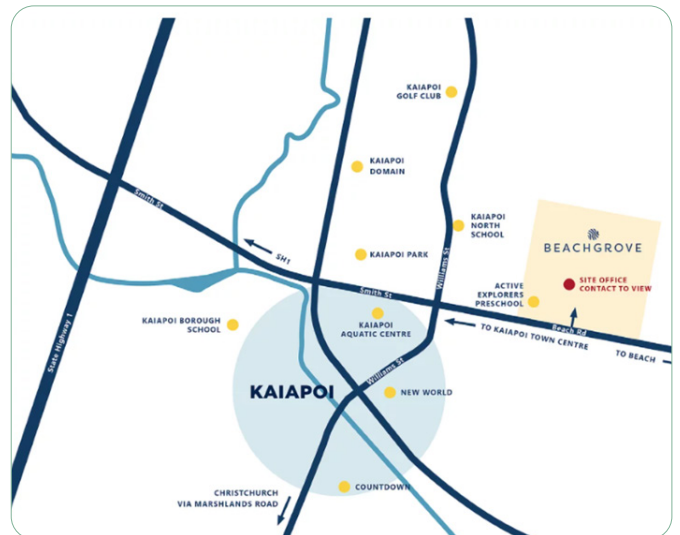

Specification

General			
Guarantee:	Master Build 10-Year	Insurance:	Builders All Risk
Warranty	1 year from settlement	Utilities:	Sewer pump chamber
Dwelling Exterior			
Foundation:	TC2 RibRaft	Framing / trusses:	2.42m LVL
Roofing:	25° longrun corrugate	Fascia and gutter:	Dimond metal fascia and quad gutter
Downpipes:	Colorsteel 75×55 rectangular	Main cladding:	Austral 70 Series Brick
Feature cladding:	James Hardie Axon	Entry door:	APL 860mm Latitude with urbo lever
Window joinery:	Low E Argon filled double glazed windows in thermally-broken powder coated aluminium frames	Garage door:	Insulated Coloursteel flat panel woodgrain 4.5m
Tint to w02 & w03			
Dwelling Interior			
Insulation:	As per Building Code. Including entire garage envelope - internal & external walls	Plasterboard:	Plasterboard - 10mm to walls, wet area to bathrooms and 13mm to ceilings
Gib stopping:	Grade 4 paint finish in accordance with AS/NZ 2311:2009	External corners:	Square stop
Hinged doors:	1980mm (horizontal V groove)	Wardrobe sliders:	2200mm Horizontal V groove
Wardrobe shelving:	MDF shelf and rail	Cupboard shelving:	MDF shelves x4
Door hardware:	Windsor Futura – Apex brushed nickel	Skirting board:	60mm bevel
Electrical:	As per plan	Heatpump:	Fujitsu SET-ASTH22KNTA 6.0/6.5kw
Extractor:	Inline extractor fan	Hot water cylinder:	Rheem 250L
Carpet:	Belgotex Urban Twist	Vinyl plank:	Belgotex Luxury Plank – Province
Kitchen, bench surface and splashback:	Custom made Melteca or Bestwood finished cabinetry. TriStone 30mm square edge benchtop. Tiled splashback full length of back bench/wall.	Window coverings:	Windoware Everyday Vinyl Collection – Mystic. Excluding garage & bathrooms
Landscaping			
Driveway and patio:	Exposed aggregate – sealed	Vehicle crossing:	Included
Soft landscaping:	As per plan	Fencing:	As per plan

Specification

Kitchen and Laundry *Refer to plans and colour scheme

Kitchen tapware:

Elementi Uno Gooseneck



Kitchen sink:

Lazio NZLSS-5545 single stainless steel sink



Oven:

Bosch HBF133BSOA



Kitchen handles:

Stefano Orlati 4062— Titanium



Powerpack:

Bosch DHL755BAU



Ceramic cooktop:

Bosch PKE611K17A



Laundry tub:

Aquatica Laundra Studio

*dependent on supply, similar fitting to be used if unavailable



Dishwasher:

Bosch SMU2ITS01A



Bathrooms

Vanities:

Elementi Novara, 2 drawer 750mm, French Oak



Mirrors:

Polished edge direct fix—1000×750mm



Showers:

Arena curved with moulded wall



Toilets:

Elementi Uno back to wall



Bath:

Elementi Diseno back-to-wall 1700mm



Towel rails:

Newtech 5 bar square—heated



Basin mixers:

Elementi Cura



Shower / bath mixers:

Elementi Cura



Shower slides:

Elementi Rayne



Bath spout:

Elementi Uno



P: (03) 977 2832

E: info@oakridgehomes.co.nz

oakridgehomes.co.nz

Colour Schedule

Exterior Colours

Colour Scheme			
EXTERIOR			
Roof:	Ebony	Garage door:	Ebony
Fascia, gutter & downpipes:	Ebony	Garage door frame:	Ebony
Window joinery:	Ebony	Soffits:	Half black white
Front door:	Ebony	Exterior cladding (Main):	Russo with natural grey mortar
Front door frame:	Ebony	Exterior cladding (Feature):	All black

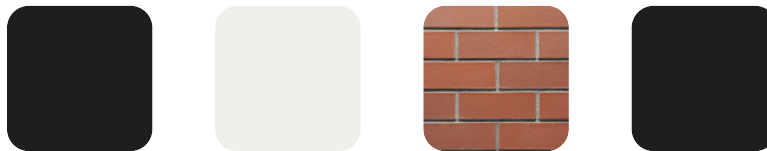

Interior Colours

Colour Scheme			
INTERIOR			
Ceilings:	Half black white	Kitchen benchtop:	TriStone 30mm – Antarctic Snow
Walls:	Black white	Kitchen back wall & island back panel:	Carbon
Interior doors:	Black white	Kitchen front island panel & boxed ends:	Southern oak
Skirting:	Black white	Kitchen splashback:	Mallorca White Gloss 50×250—vertical stack with misty grey grout
Carpet:	Iron	Feature pendant:	Elba 365 black
Vinyl plank:	Natural		

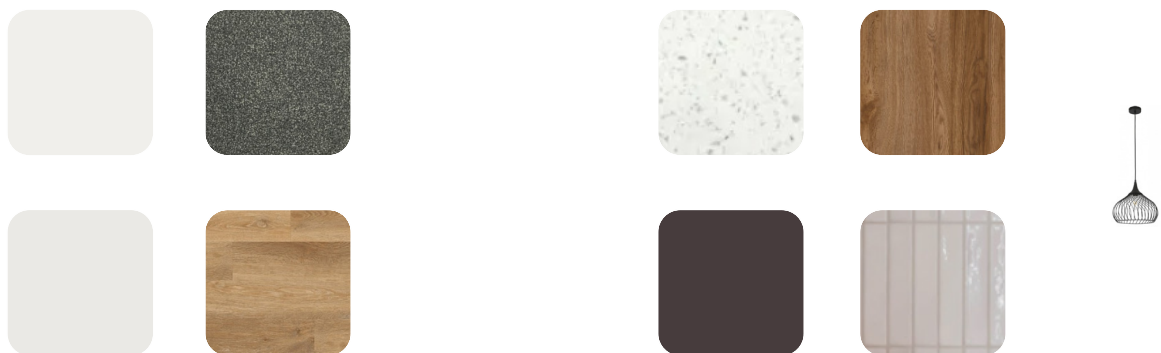

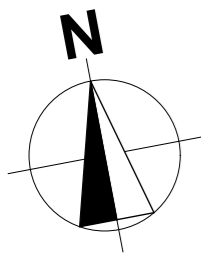

Site Info

Site Address	Tuuta Street Beach Grove
Legal Description	Lot 351
Site Area	325m ²
Building Area	143.38m ²
Roof Area*	176.36m ²
Site Coverage	54.26%

Design Basis

Wind Zone	High
Earthquake Zone	2
Snow Zone	N4 < 100m
Exposure Zone	C

General Notes

All dimensions shown are to face of foundation unless noted otherwise.

Refer to Foundation Plan for foundation setout.

Refer to Drainage Plan for specific drainage info.

Refer to Sediment Control in Specification & implement where required.

All sealed driveway and patio areas to be min. 1:100 fall away from building.

Site bearings, dimensions and North point subject to Certificate of Title.

Site Specific Notes

Visibility Splays measuring 2m along road boundary to a length of 2.5m along internal boundary. Keep clear of obstructions within visibility splays areas. Landscaping or any other features within the visibility splays areas shall not exceed 0.5m in height.

Datum

Levels are in terms of Lyttelton Vertical Datum 1937. Origin of Levels is MN127 = RL 1.471 (2018)

Coordinates are in terms of local circuit Mount Pleasant 2000.

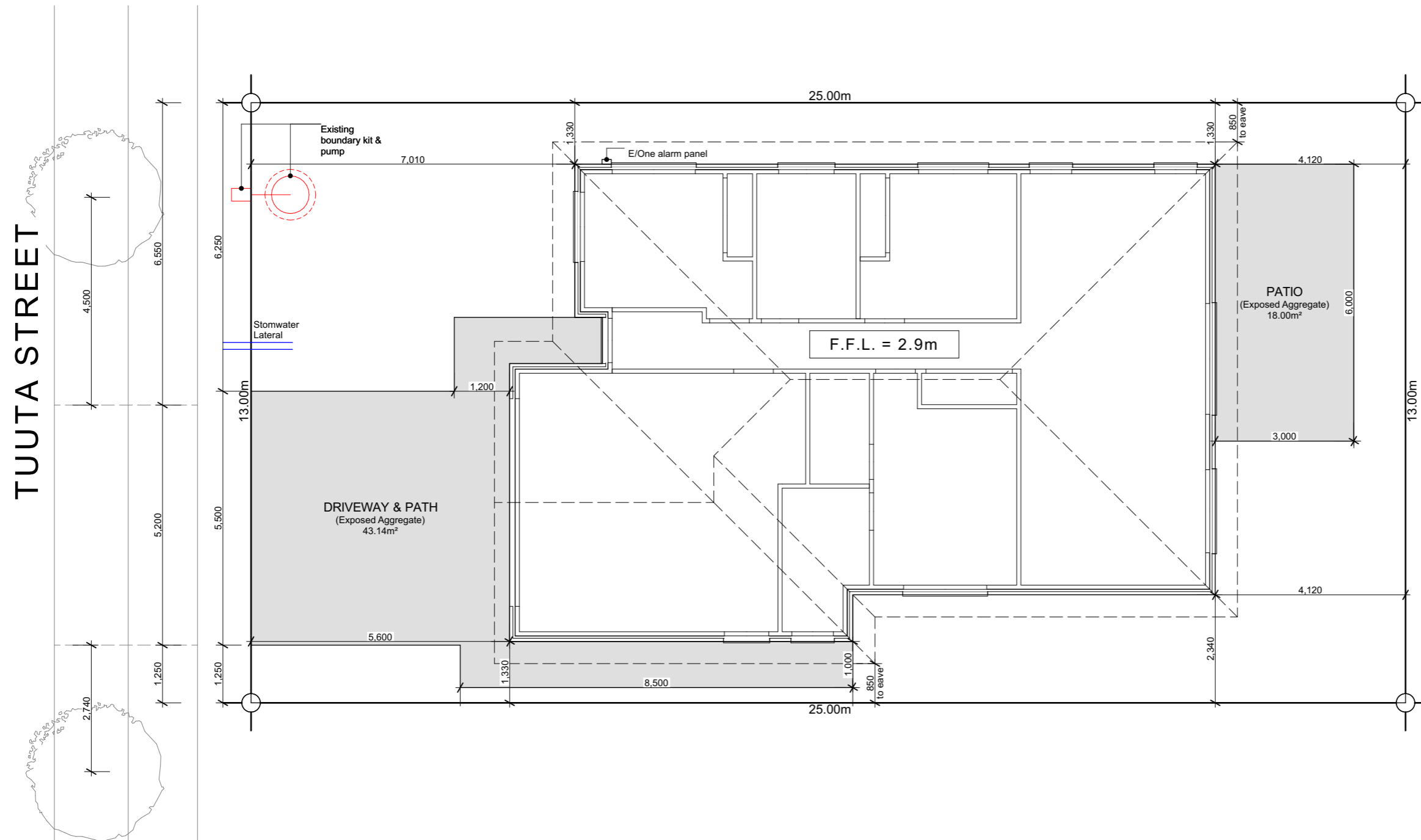

6 Browns Road, Christchurch
 ey.archiplus@gmail.com
 021 0238 1905
 021 0221 8868



W E N D E L B O R N
P R O P E R T Y L T D
 LOT 351 BEACH GROVE
 TUUTA STREET KAIAPOI

Issue
 Building Consent

This plan is developed for the purchaser
 and is copy right to Archiplus Ltd.

Site Plan

Scale 1:100 @ A3

Revision BC-1
 Date 4/05/2026
 File No. 25257 (ORH. 3488)

Sheet No.

1.01

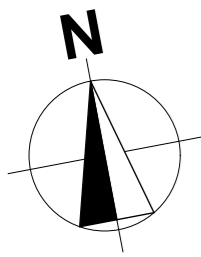

Building Area

Over Frame	137.14m ²
Perimeter	51.48m
Over Cladding	143.38m ²
Perimeter	53.62m
Roof Area*	176.36m ²
Perimeter	55.80m

*Roof area includes fascia & gutter

General

Main Cladding	70s Clay Brick
Feature Cladding	James Hardie Axon Panel
Roof Pitch	25°
Roofing	Longrun Corrugated
Stud Height	2.42m
Interior Door	1.98m high
Wardrobe Door	2.20m high
Cooktop	Ceramic Cooktop

Note 1: Kitchen layout indicative only, refer to Kitchen Design for details.

Note 2: Window tint to w02 & w03.

Legend

	Distribution Board & Smart Meterbox
	Data Box
	Smoke Detector 10 year long-life battery-operated & interconnected

Floor Covering

	Carpet (excl. Garage)
	Vinyl Planks

WINDOW SCHEDULE		
ID	H	W
w01	2,130	960
w02	2,130	1,500
w03	500	1,800
w04	1,100	1,200
w05	1,400	1,500
w06	2,130	900
w07	2,130	900
w08	2,130	2,400
w09	1,100	1,800
w10	1,400	1,800
w11	1,100	900
w12	2,130	960

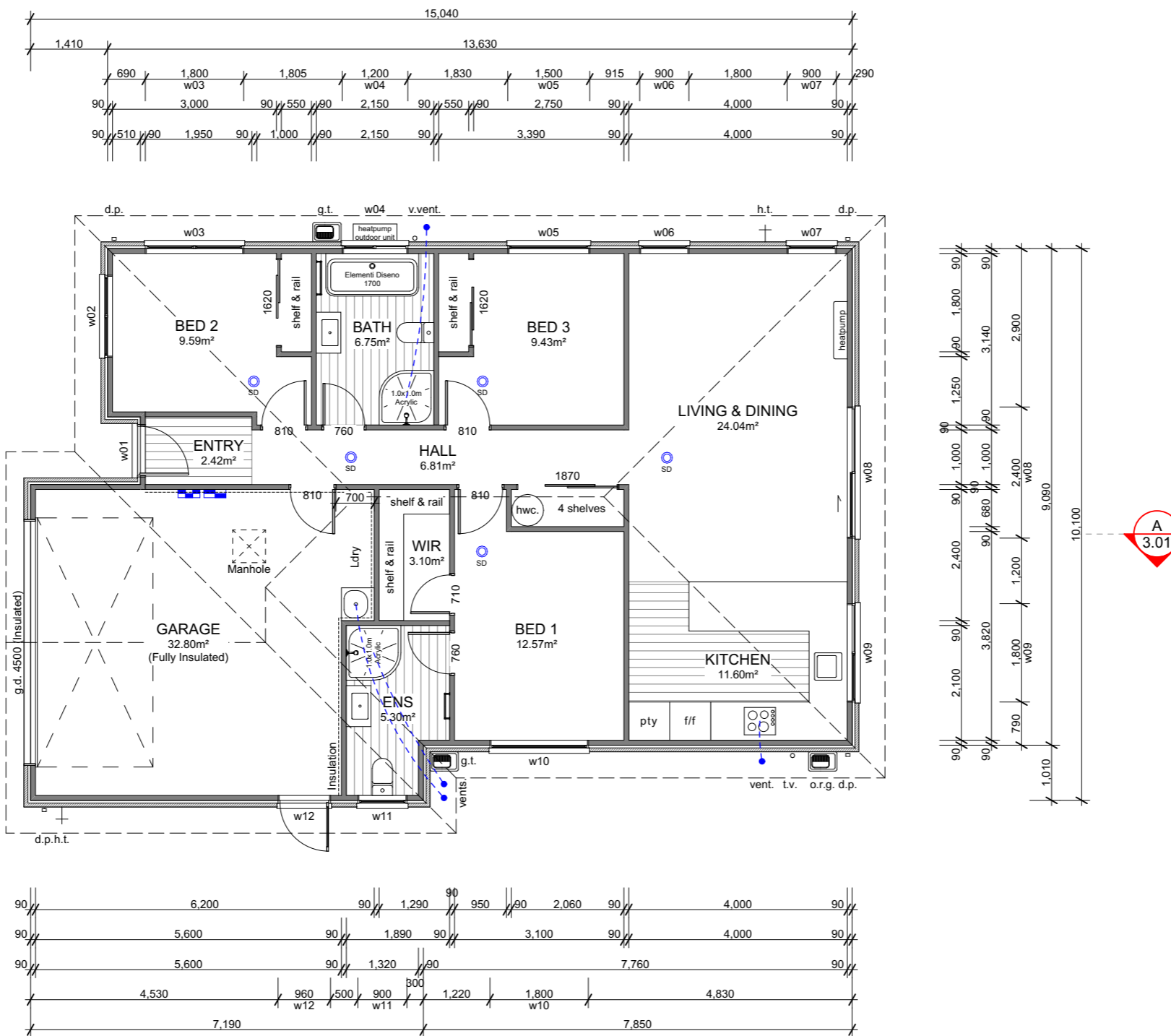

6 Browns Road, Christchurch
 ey.archiplus@gmail.com
 021 0238 1905
 021 0221 8868



W E N D E L B O R N
P R O P E R T Y L T D
 LOT 351 BEACH GROVE
 TUUTA STREET KAIAPOI

Issue
 Building Consent

This plan is developed for the purchaser
 and is copy right to Archiplus Ltd.

Floor Plan

Scale 1:100 @ A3

Revision BC-1
 Date 4/05/2026
 File No. 25257 (ORH. 3488)

Sheet No.

1.05

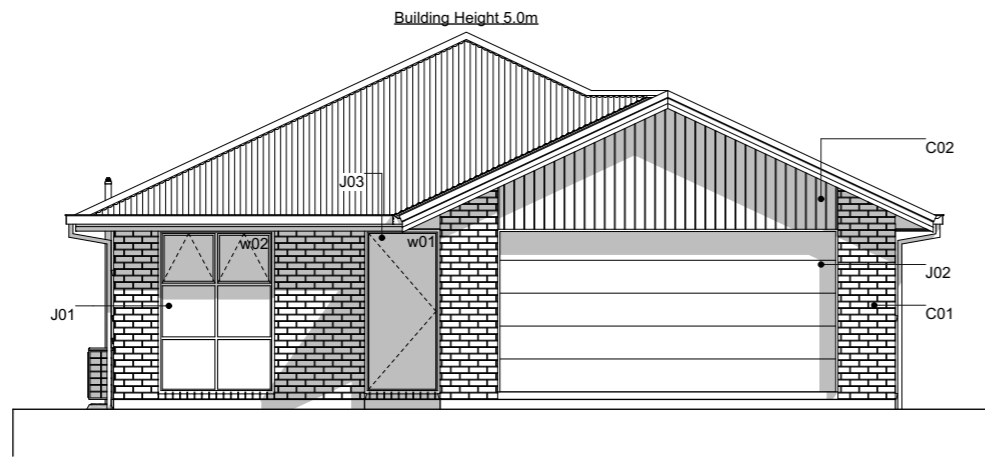

E-01 West Elevation
Scale 1:100

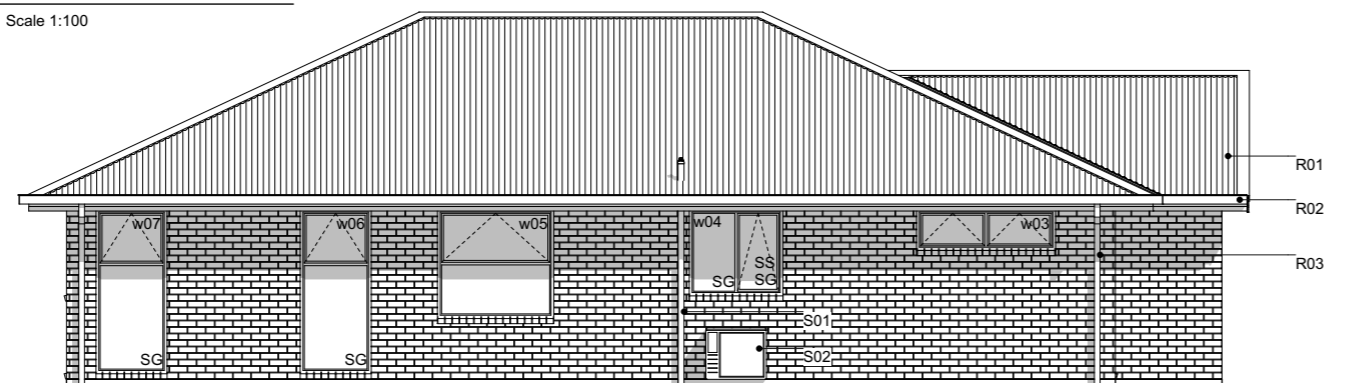

E-02 North Elevation
Scale 1:100



E-03 East Elevation
Scale 1:100

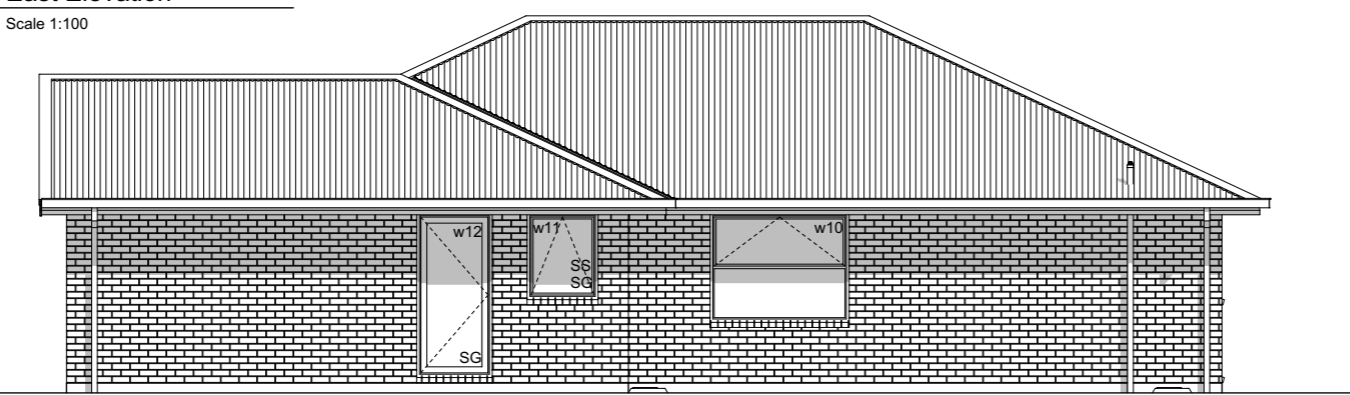

E-04 South Elevation
Scale 1:100

Elevation Keys

- C01 70 series brick on 50mm cavity.
- C02 James Hardie Axon panel on 20mm cavity battens.
- R01 Colorsteel corrugate roofing.
- R02 Colorsteel Quad gutter supported by Colorsteel 185mm fascia.
- R03 Colorsteel 75x55mm downpipes.
- J01 Low E Argon filled double glazed windows in thermally-broken powder coated aluminium frames.
- J02 Sectional garage door.
- J03 APL entry door in thermally-broken powder coated aluminium frames.
- S01 Drainage vent pipe.
- S02 Heatpump outdoor unit on wall bracket.

Legend

- w01 Window ID
- SS Security Stay
- SG Safety Glass

General Notes

Driveway to fall from 20mm max. below garage rebate.

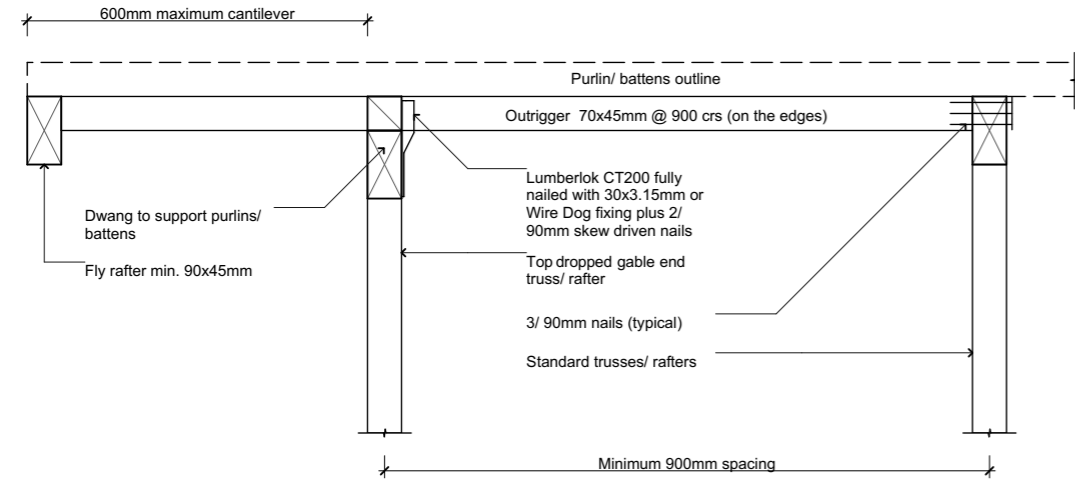

Outrigger Fixing Detail
Scale NTS

Section Keys

- C01 70 series brick on 20mm cavity battens over building wrap on timber framing.
- C02 James Hardie Axon panel on 20mm cavity battens over building wrap on timber framing.
- W01 External walls 90x45mm studs @ 600mm crs, dwangs @ 800mm crs. Top plates 90x45 + 140x35mm.
- W02 Internal walls 90x45mm studs @ 600mm crs, dwangs @ 800mm crs.
- S01 Ribraft foundation.
- T01 Roof trusses as per Truss Design.
- R01 Colorsteel corrugate roofing over self-supported roof underlay on 70x45mm purlins on trusses.
- R02 Colorsteel Quad gutter on 185mm Colorsteel fascia.
- R03 75x55mm Colorsteel downpipes with wall brackets.
- J01 Low E Argon filled double glazed windows in thermally-broken powder coated aluminium frames. H3.1 timber reveals for painted finish.
- J02 Sectional garage door. H3.1 timber reveals for painted finish.
- B01 R2.6 wall insulation batts.
- B02 2 x R3.6 (165mm) double layer ceiling insulation batts.
- B03 R3.6 (140mm) insulation batts cut to size between the trusses and fit at the first 500mm from the centre of top plate. Maintain 25mm ventilation gap between top of insulation and roofing underlay.
- L01 4.5mm Hardie soffit linings for painted finish.
- L02 13mm Gib ceiling linings supported by 35mm Rondo ceiling battens @ 600mm crs. Stopped smooth for painted finish. (Wet area ceiling 13mm Gib Aqualine)
- L03 10mm Gib wall linings stopped smooth for painted finish. (Wet area wall 10mm Gib Aqualine)

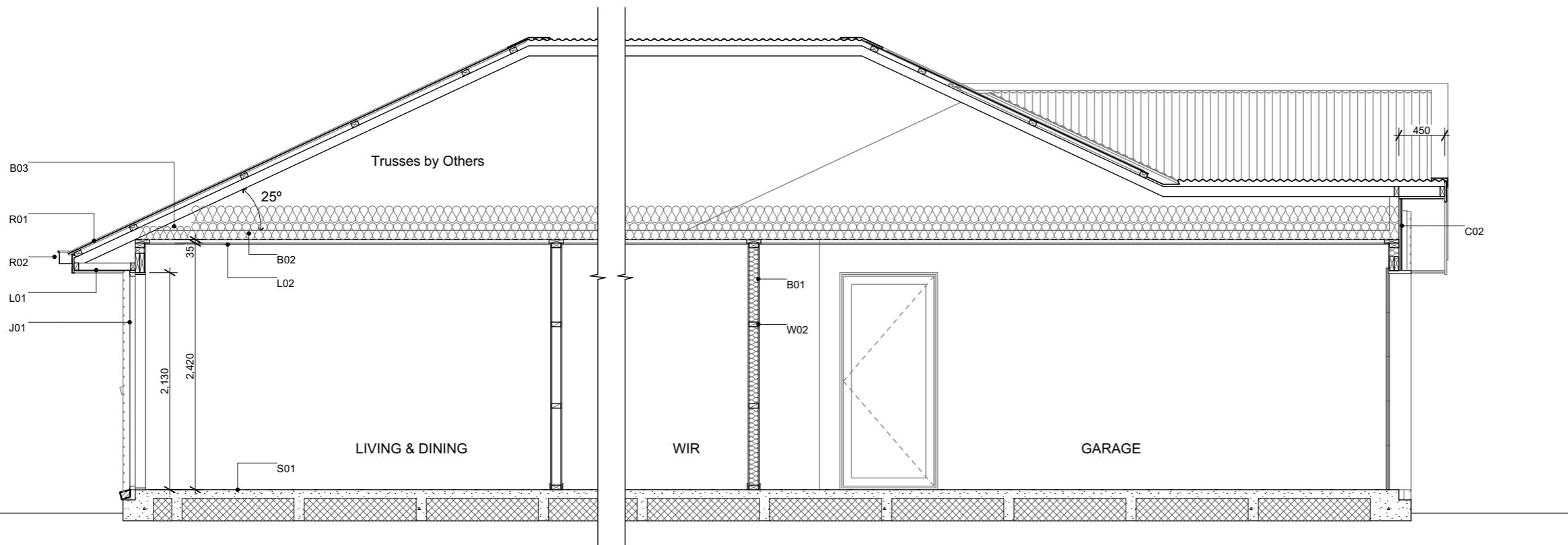

A Section A-A
Scale 1:50

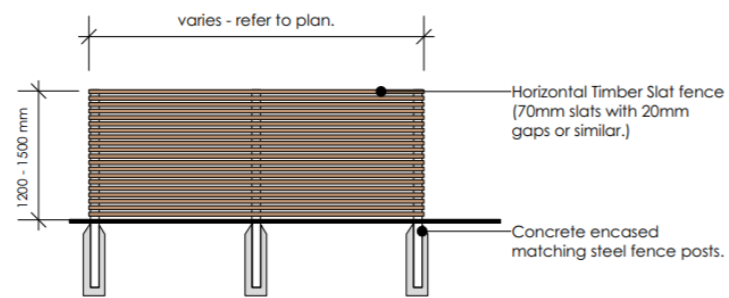
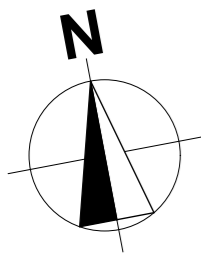

2 FENCE TYPE 1200 - 1500mm High Horizontal Timber Slat Fence
Scale 1:50

NOTE: 1.8m high fence version suitable where adjacent to outdoor courtyards.

To be stained to tie in with house facade.

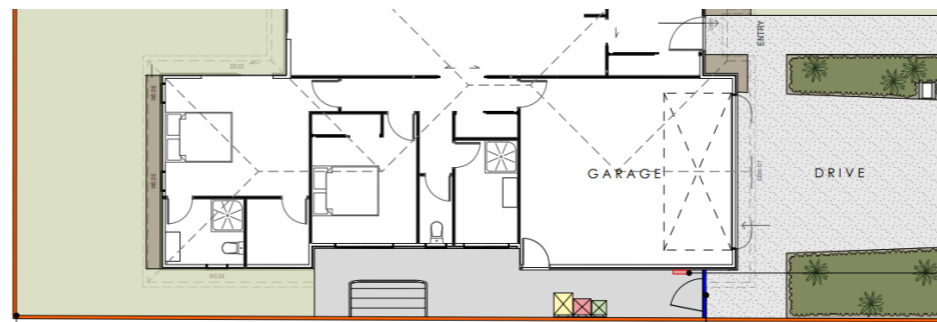

Fence Type 4 to all internal boundaries

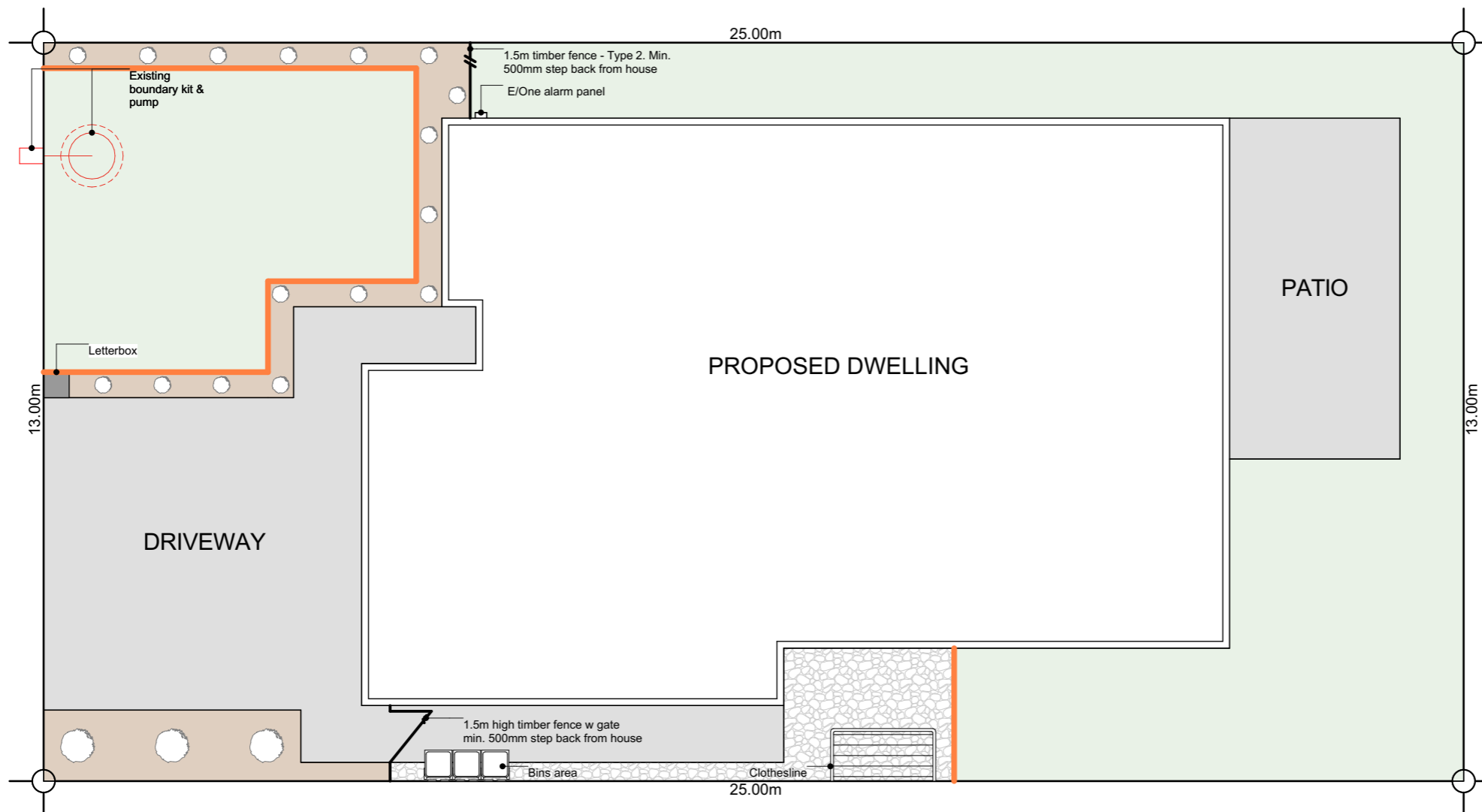

5 Indicative Landscape Plan
Scale 1:100



Plants List for Garden Bed

- Agapanthus Peter Pan - Dwarf blue Nile lily
 - Acacia Limelight - Dwarf wattle
 - Choisya Ternata - Mexican orange blossom
 - Carex Secta - Makura sedge
 - Lavandula angustifolia 'Hidcote' - English Lavender
 - Pittosporum little gem
 - Thuja occidentalis Smaragd - Emerald Cedar
 - Viburnum tinus Eve Price
 - Azalea
 - Corokia geentys green
 - Pseudowintera colorata 'Red Leopard' - Horopito/Pepper tree
 - Camellia 'Cinnmon Cindy'
- *Planting species for garden bed are indicative-not to be limited to.

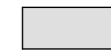
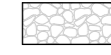
Legends

-  Lawn
-  Exposed Aggregate
-  Stonechip
-  Garden Bed with Bark
-  Timber Batten Edging between garden bed & lawn/ stonechip



6 Browns Road, Christchurch
ey.archiplus@gmail.com
021 0238 1905
021 0221 8868



**W E N D E L B O R N
P R O P E R T Y L T D**
LOT 351 BEACH GROVE
TUURA STREET KAIAPOI

Issue
Concept Design

This plan is developed for the purchaser and is copy right to Archiplus Ltd.

Landscape Plan

Scale 1:100 @ A3

Revision 2
Date 26/11/2025
File No. 25257

Sheet No.

1

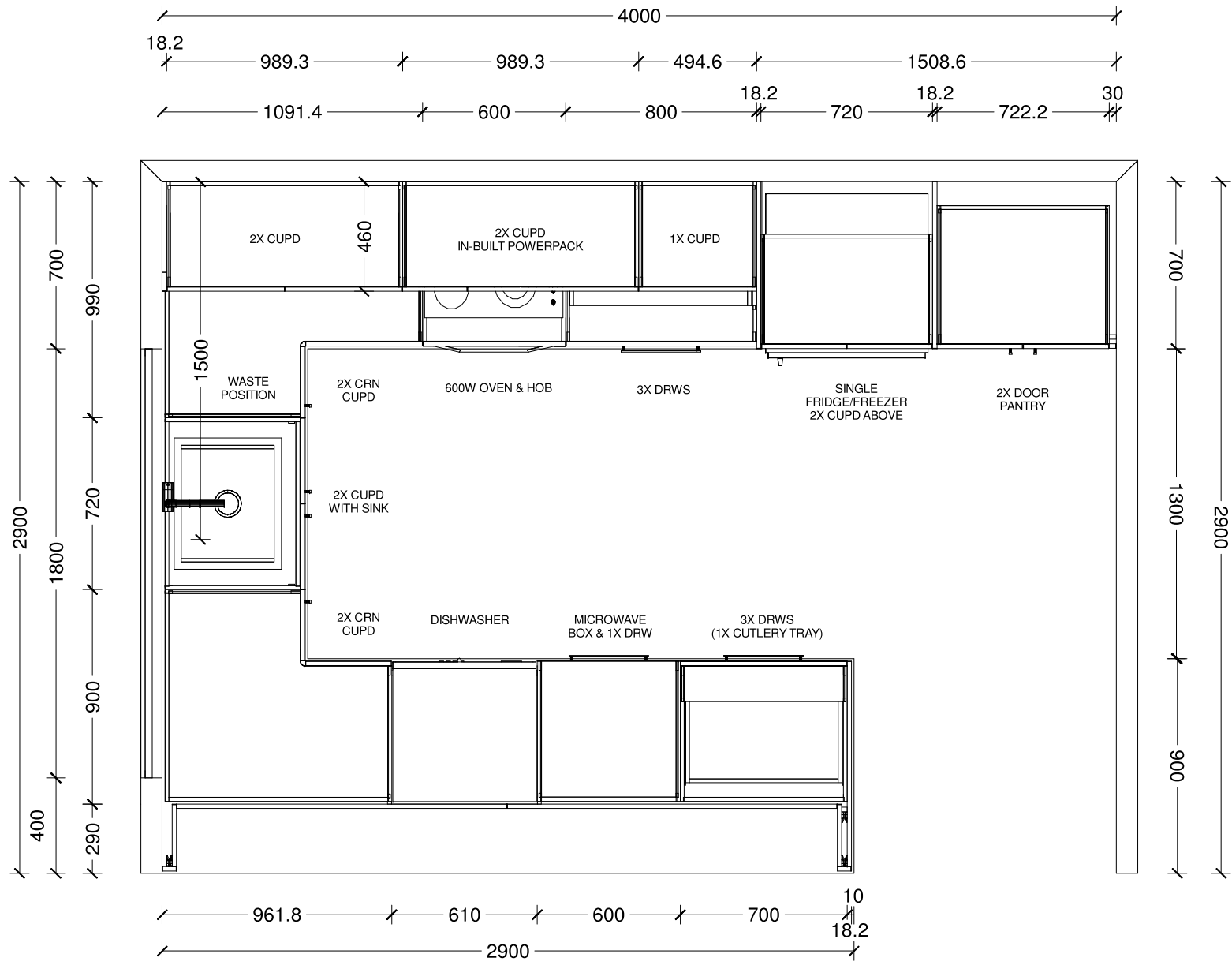

Designer: Sarah Molyneux	Date: 03 Dec 25	Client: Oakridge Homes	BC Ref:	Site Address:	Job#: Default	
Dwg: Kitchen Plan	Scale: 1 : 25	Customer: The Titoki				

This is an original design and must not be released or copied unless applicable fee has been paid or job order placed. All dimensions and size designations given are subject to verification on job site and adjustment to fit job conditions.

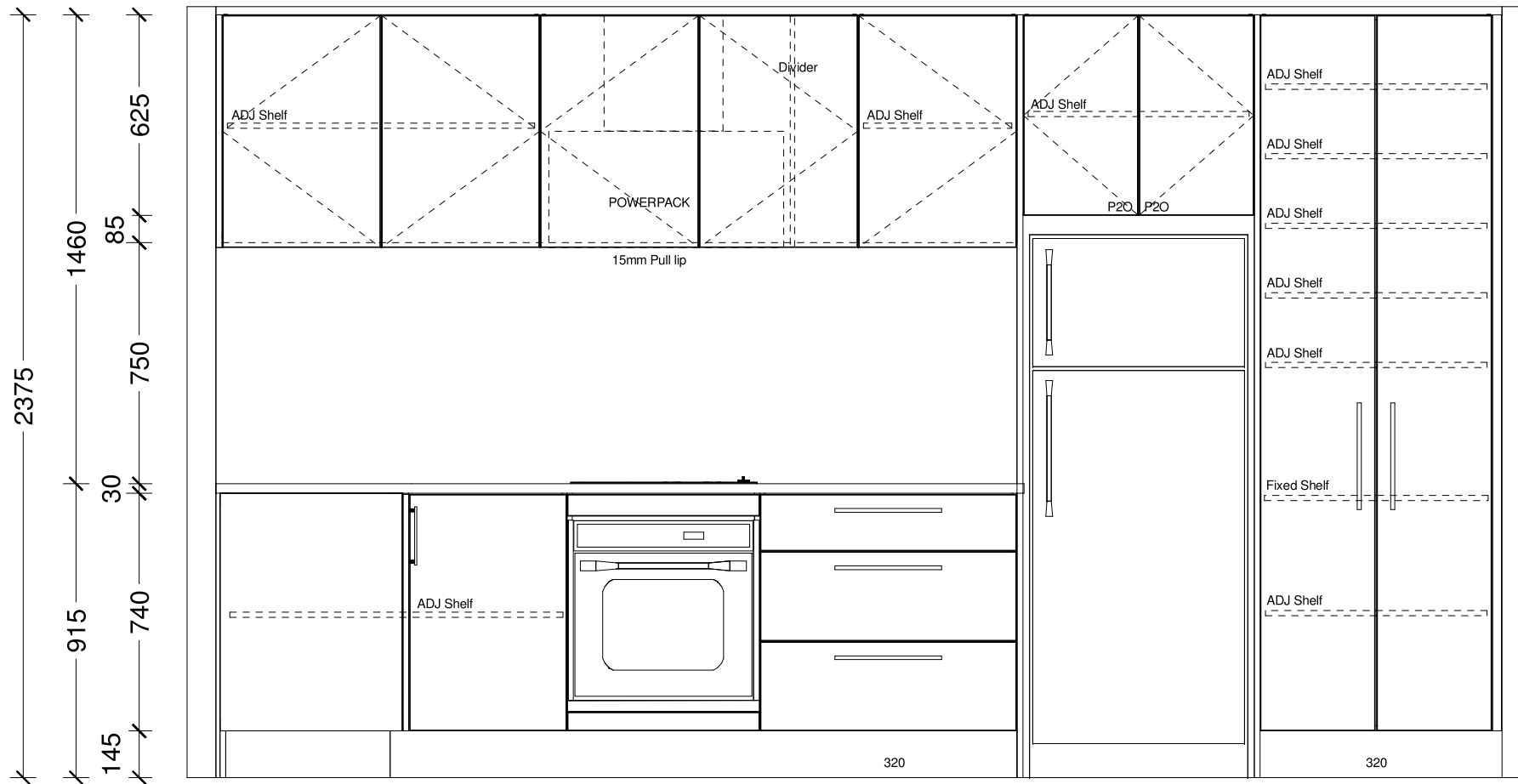

Designer: Sarah Molyneux	Date: 03 Dec 25	Client: Oakridge Homes	BC Ref:	Site Address:	Job#: Default	
Dwg: Kitchen Elevation	Scale: 1 : 20	Customer: The Titoki				

This is an original design and must not be released or copied unless applicable fee has been paid or job order placed. All dimensions and size designations given are subject to verification on job site and adjustment to fit job conditions.

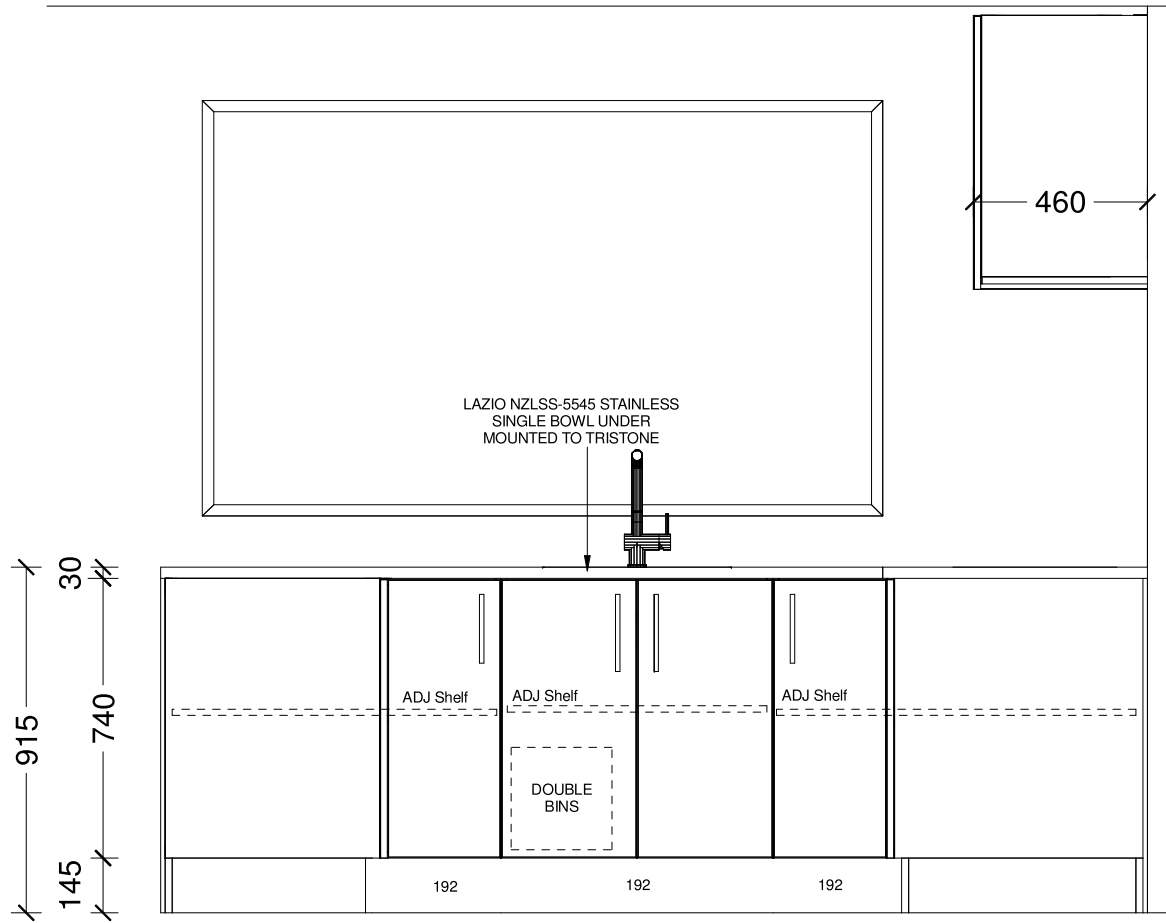

Designer: Sarah Molyneux	Date: 03 Dec 25	Client: Oakridge Homes	BC Ref:	Site Address:	Job#: Default	
Dwg: Kitchen Elevation	Scale: 1 : 20	Customer: The Titoki				

This is an original design and must not be released or copied unless applicable fee has been paid or job order placed. All dimensions and size designations given are subject to verification on job site and adjustment to fit job conditions.

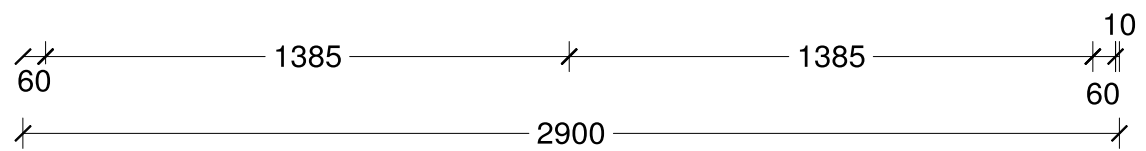
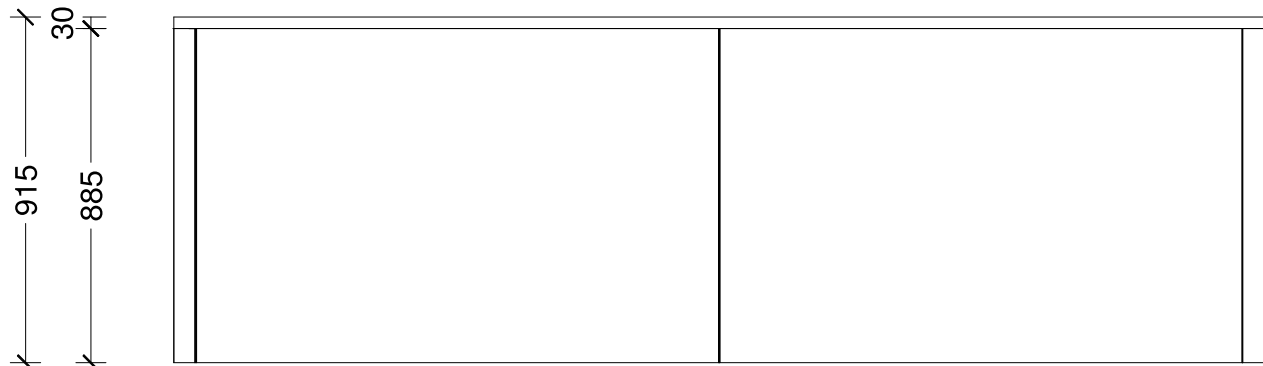
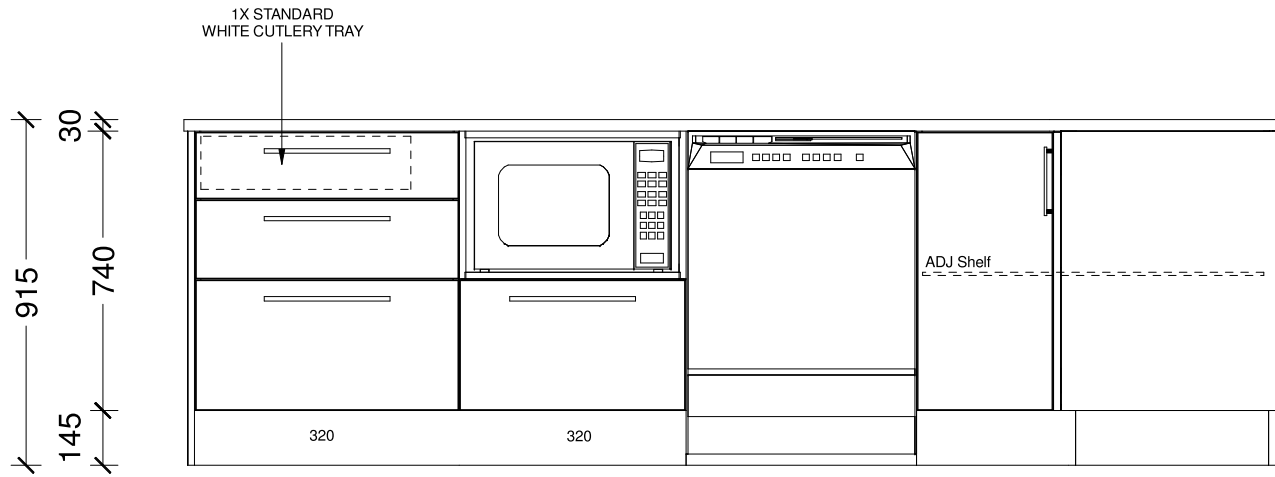

Designer: Sarah Molyneux	Date: 03 Dec 25	Client: Oakridge Homes	BC Ref:	Site Address:	Job#: Default	
Dwg: Kitchen Elevation	Scale: 1 : 20	Customer: The Titoki				

This is an original design and must not be released or copied unless applicable fee has been paid or job order placed. All dimensions and size designations given are subject to verification on job site and adjustment to fit job conditions.

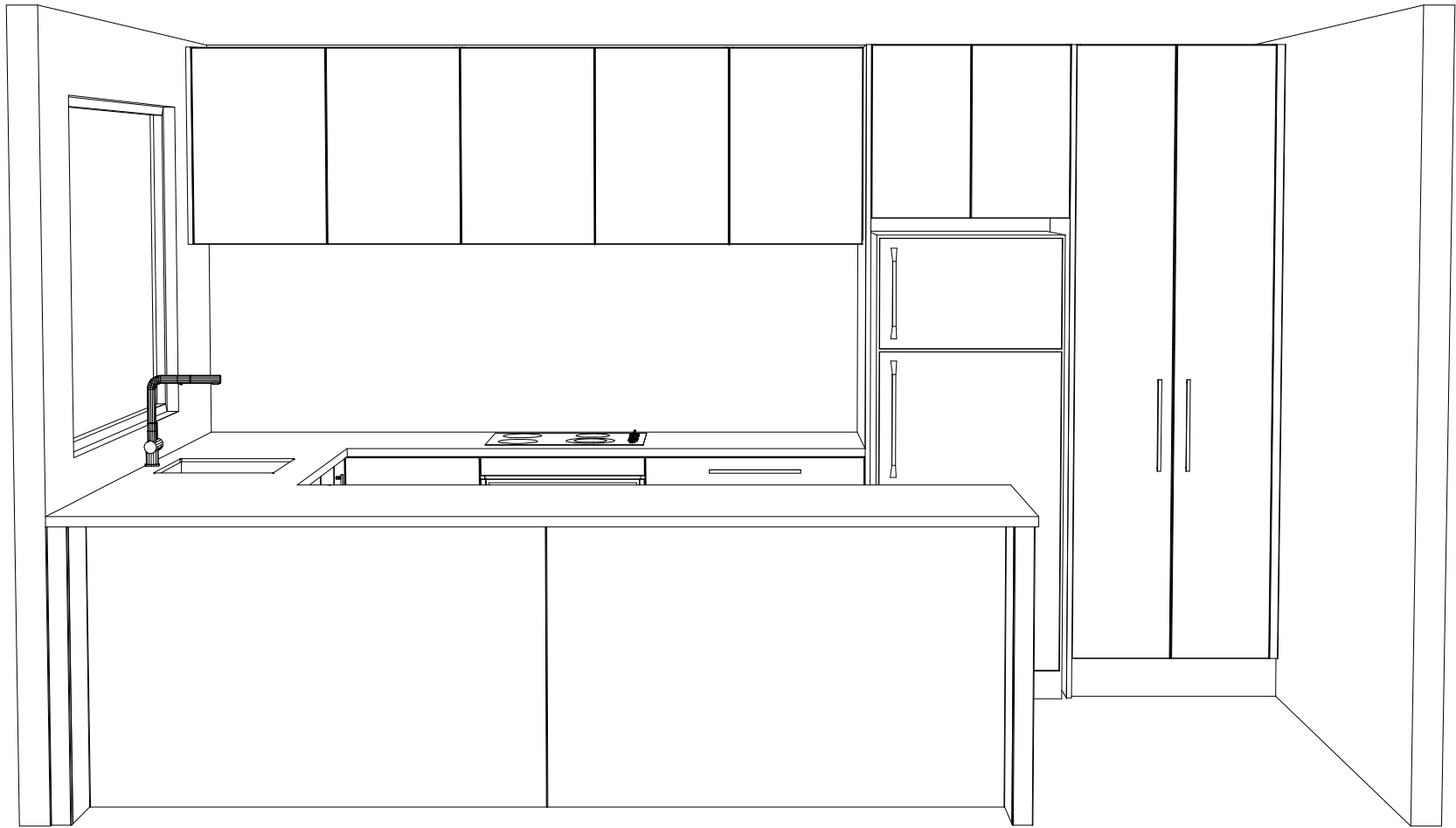

Designer: Sarah Molyneux	Date: 03 Dec 25	Client: Oakridge Homes	BC Ref:	Site Address:	Job#: Default	
Dwg: Kitchen 3D Perspective	Scale:	Customer: The Titoki				

This is an original design and must not be released or copied unless applicable fee has been paid or job order placed. All dimensions and size designations given are subject to verification on job site and adjustment to fit job conditions.

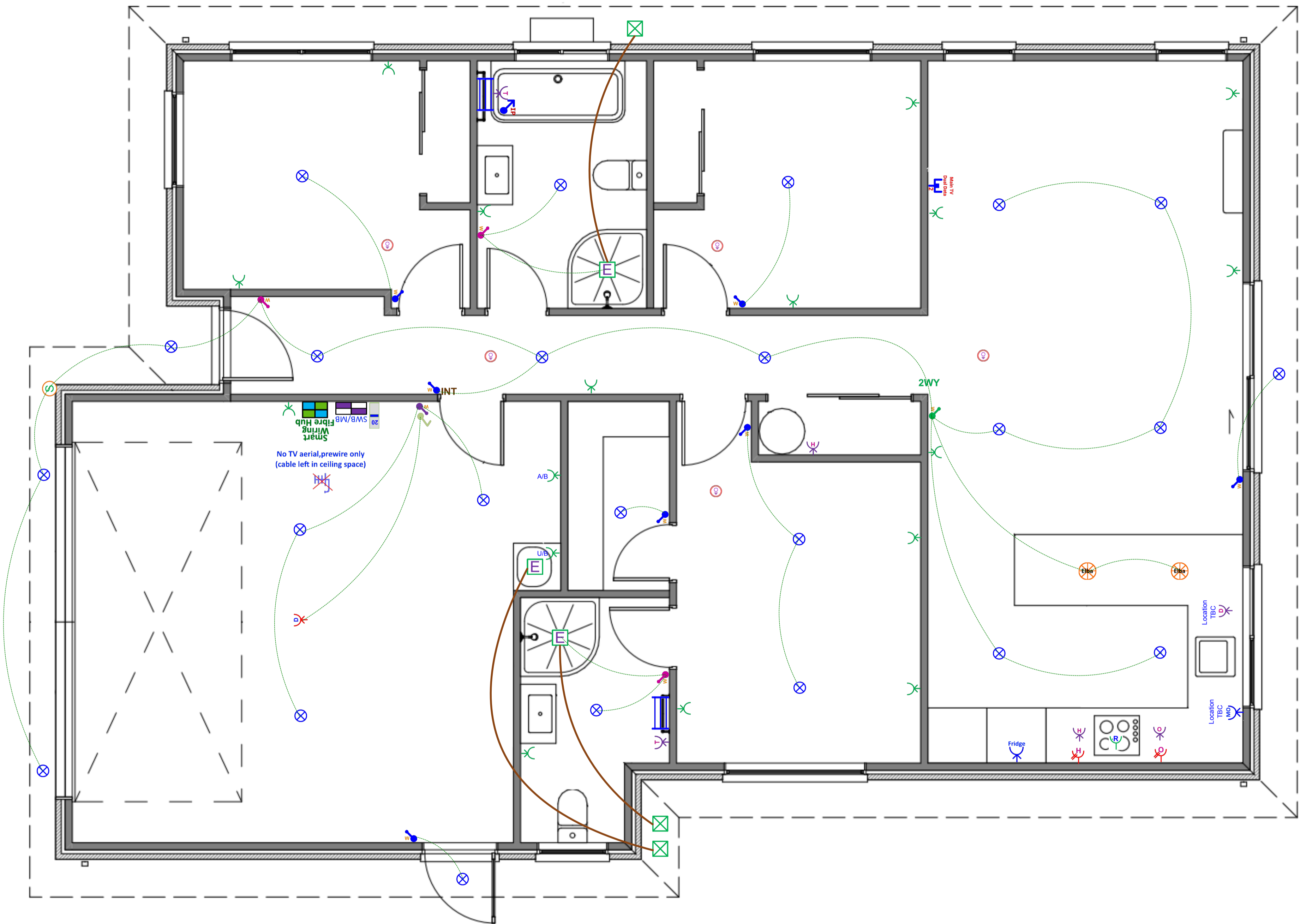



Plan: Option C - The Elba - The Titoki

Oakridge Power & Lighting

Item	Total
 Electrical Base with 34-Way Deep Combined Meter Switchboard (Single Phase)	1 EA
 Rangehood Single Power Socket	1 EA
 Tradesave Slim Single Power Socket (White) 10A - Fridge	1 EA
 Tradesave Slim Single Power Socket (White) 10A - Microwave	1 EA
 Tradesave Slim Double Power Socket Horizontal (White) 10A	17 EA
 Tradesave Slim Double Power Socket with Oven Isolator Switch (White) 10A	1 EA
 Tradesave Slim Double Power Socket with Hob Isolator Switch (White) 10A	1 EA
 Tradesave Built-In Oven Hard-Wired Power Connection up to 20A (max)	1 EA
 Tradesave Slim Electric Hob Hard-Wired Power Connection up to 32A (max)	2 EA
 Tradesave Slim Dishwasher Power Socket (White)	1 EA
 Tradesave Slim Garage Door Open/Close Press Switch (White)	1 EA
 Tradesave Slim Garage Door Power Socket (White)	1 EA
 Air Conditioning Circuit 20A MCB Installation For Heat Pump Circuit	1 EA
 Orca OM866S-10RF Wireless Interconnected Smoke Detector - Photoelectric 10-year battery life	5 EA
 Newtech ST65 Towel Rail 5-Bar Square Ladder 530 x 600mm (Chrome) - Excludes Circuit & Installation	2 EA
 Tradesave Slim Heated Towel Rail Circuit & Installation (Excludes supply of Towel Rail)	2 EA
 Extractor Fan Inline 150mm & up to 6m of duct	3 EA
 Extractor Fan External Grille (White)	3 EA
 External 180° Infrared Movement Surface Mounted Sensor Up to 12M Range, Adjustable 10sec - 15min time delay (White)	1 EA
 Recessed Downlight Prolux DL54 LED 10-Watt 160° Beam (Switchable 3K-4K-6K) White Fascia & Circuit	24 EA
 Pendant Light - Elba 365mm with 8-watt LED Lamp (Black) & Circuit	2 EA
 Tradesave Slim Light Switch 1-Gang (White)	7 EA

Oakridge Power & Lighting

Item	Total
 Tradesave Slim Light Switch 2-Gang (White)	3 EA
 Tradesave Slim Light Switch 3-Gang (White)	1 EA
 Tradesave Slim Light Switch 4-Gang (White)	1 EA
 Excel Life White IP Rated Light Switch 1 Gang	1 EA
2WY 2-Way Light Circuit	1 EA
INT Tradesave Slim 3-way Intermediate Switching Light Circuit	1 EA
 Smart Wiring Base 20" Hub 12-Port with Fibre Optic Pathway and Power Circuit	1 EA
 Tradesave Slim Main UHF TV/Dual Network Data Sockets Cat-6 (White)	1 EA
 No TV Aerial, pre-wire only (cable left in ceiling space)	1 EA

In the Area

About Beachgrove

Beachgrove offers the best of both worlds with its generous green spaces, leafy surroundings, and peaceful, semi-rural feel, all while being just 900 metres from central Kaiapoi. Everyday essentials, shopping, and local amenities are only minutes away, and with the new Christchurch Northern Corridor, commuting to the Christchurch CBD takes as little as 15 minutes.

Families will appreciate the convenience of having an onsite childcare centre, Active Explorers, and direct access to Kaiapoi North School, a full Year 1–8 primary school bordering the development. With the school just a short walk through the back gate, the morning run couldn't be easier.



Kaiapoi and Surrounding Areas

Kaiapoi is a vibrant riverside town just north of Christchurch, known for its friendly community feel, charming town centre, and relaxed lifestyle. Set along the Kaiapoi River, it offers easy access to walking tracks, parks, and nature, while recent redevelopment has brought modern amenities, great cafés, and boutique shopping to the area. Just minutes from the heart of town, the Beachgrove subdivision provides a contemporary, master-planned neighbourhood that blends seamlessly into Kaiapoi's leafy, welcoming surroundings.

Its close proximity to Christchurch means residents enjoy the best of both worlds—peaceful suburban living with the convenience of the city only a short drive away. The wider Waimakariri district offers beautiful beaches, quality schools, nature reserves, and plenty of outdoor adventure. With strong local infrastructure and a warm, community-driven atmosphere, Kaiapoi and the nearby Beachgrove subdivision continue to be among Canterbury's most desirable places to call home.



P: (03) 977 2832

E: info@oakridgehomes.co.nz

oakridgehomes.co.nz

Why Choose an Oakridge Home?

Oakridge Homes is a locally owned Canterbury company with decades of experience. We are Canterbury's second largest residential builder delivering 200 homes per year with a proven track record of completing over 400 homes for happy homeowners in the region. Oakridge is a small team of fifteen, each of us working diligently to achieve the company goal of delivering quality homes as efficiently and stress free as possible.

All Oakridge house and land packages are competitively priced offering true value for money including turnkey funding, meaning you pay a 10% deposit and the balance the day you get your keys. In our experience this is the preferred contract method when securing finance and a service we offer as a standard inclusion. We work closely with our contractors and suppliers to get the best product for the best cost which is reflected in our all-inclusive package pricing.

At Oakridge we are extremely proud of the relationships we have built with local tradesmen and suppliers, ensuring quality is delivered every time. We deal with one longstanding company per

element of the build which has helped us achieve our average build time of 17 weeks. We are very thankful to everyone who makes an Oakridge home come to life, many of us working alongside one another for over ten years.

Our team has put immense effort in to streamlining the consenting process by working alongside the local councils and have formed great relationships with the team leaders guaranteeing our consents are handled as efficiently as possible. Oakridge has a reputation for providing quality documentation for our consent applications which helps ensure we receive your building consent in a timely manner.

We understand that customers value quality and transparency which has been a major focus for Oakridge Homes, we offer a range of fixed price turnkey house and land packages that suit the majority of homebuyers. From the letterbox numbers to the window coverings – an Oakridge home truly is fully inclusive and move in ready when handover day comes. There are no hidden surprises and nothing for you to do but sit back and trust us to build your home.

Oakridge Homes has taken steps to ensure your home is here to stand the test of time by including:

- ✓ Master Build 10-Year Guarantee
- ✓ 1 year warranty period
- ✓ Exceeds Healthy Homes Standards
- ✓ LVL framing (laminated veneer lumber) more durable and less likely to warp
- ✓ RibRaft foundation system
- ✓ Quality cladding options
- ✓ Thermally broken window joinery
- ✓ Increased carpet underlay thickness
- ✓ Tri-Stone benchtops for easy maintenance
- ✓ Full height kitchen joinery to avoid dust collection
- ✓ Full length tiled splashback to kitchen
- ✓ Bosch appliances
- ✓ Exposed aggregate driveways and patios
- ✓ Insulated garage and garage door

P: (03) 977 2832

E: info@oakridgehomes.co.nz

oakridgehomes.co.nz



The Oakridge Journey



If you'd like more information on one of our listings or want to learn more about the process of buying an Oakridge home, get in touch.

P: (03) 977 2832

E: info@oakridgehomes.co.nz

oakridgehomes.co.nz